

OPTION PARTS

Wireless kit



WARNING

- Fasten the wiring to the terminal securely and hold the cable securely so as not to apply unexpected stress on the terminal.
Loose connection or hold will cause abnormal heat generation or fire.
- Make sure the power supply is turned off when electric wiring work.
Otherwise, electric shock, malfunction and improper running may occur.



CAUTION

- DO NOT install the wireless kit at the following places in order to avoid malfunction.

(1) Places exposed to direct sunlight	(8) Places where the receiver is influenced by the fluorescent lamp (especially inverter type) or sunlight.
(2) Places near heat devices	(9) Places where the receiver is affected by infrared rays of any other communication devices
(3) High humidity places	(10) Places where some object may obstruct the communication with the remote controller
(4) Hot surface or cold surface enough to generate condensation	
(5) Places exposed to oil mist or steam directly	
(6) Uneven surface	
(7) Places affected by the direct airflow of the AC unit.	
- DO NOT leave the wireless kit without the cover.
In case the cover needs to be detached, protect the receiver with a packaging box or bag in order to keep it away from water and dust.



Note

- Instruct the customer how to operate it correctly referring to the instruction manual.
- For the installation method of the air conditioner itself, refer to the installation manual enclosed in the package.



FDK Series

- RCN-K-E (Models : FDK22~56)
- RCN-K71-E (Model : FDK71)



PHA012D038

WIRELESS KIT INSTALLATION MANUAL

⚠ WARNING

- **Use specified wire for electrical wiring, fasten the wiring to the terminal securely, and hold the cable securely in order not to apply unexpected stress on the terminal.**
Loose connections or hold could result in abnormal heat generation or fire. 
- **Turn off the power source during servicing or inspection work.**
If the power is supplied during servicing or inspection work, it could cause electric shock and injury by the operating fan. 
- **Shut off the power before electrical wiring work.**
It could cause electric shock, unit failure and improper running. 



⚠ CAUTION

- **DO NOT install it on the following places.**
 - (1) Places exposed to direct sunlight
 - (2) Places near heat devices
 - (3) High humidity places
 - (4) Hot surface or cold surface enough to generate condensation
 - (5) Places exposed to oil mist or steam directly
 - (6) Places where the receiver is influenced by the fluorescent lamp (especially inverter type) or sunlight.
 - (7) Places where the receiver is affected by infrared rays of any other communication devices 
 - (8) Places where some object may obstruct the communication with the remote controller 
- **DO NOT leave the wireless kit without the cover.**
In case the cover needs to be detached, protect the receiver with a packaging box or bag in order to keep it away from water and dust. 

- Attention**
- Instruct the customer how to operate it correctly referring to the instruction manual.
 - For the installation method of the air conditioner itself, refer to the installation manual enclosed in the package.

① Accessories

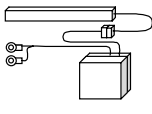
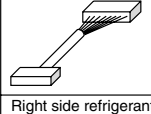
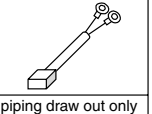
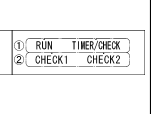
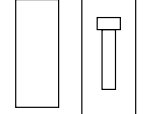
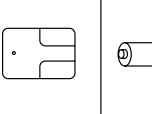
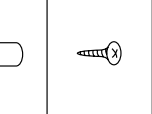
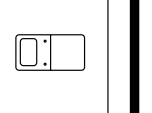
Please make sure that you have all of the following accessories.

Control ASSY	Wiring ASSY (A)	Wiring ASSY (B)	Display label	Rubber insulation	Tie	Remote controller holder	AAA dry cell battery(RO3)	Wood screw for holder	Wireless remote controller
									
1	1	1	1	1	3	1	2	2	1

Right side refrigerant piping draw out only

② Preparation before installation

Setting on site

Interface PCB has the following switches to set the function.
Default setting is shown with mark.

SW1-1	Prevents interference during plural setting	ON : Normal (1ch) OFF : Customized (2ch)
SW1-2	Receiver master/slave setting	ON : Master OFF : Slave
SW1-3	Buzzer valid/invalid	ON : Valid OFF : Invalid
SW1-4	Auto restart	ON : Valid OFF : Invalid
SW1-5	Indication for error	ON : Valid OFF : Invalid
SW1-6	Not in use	ON : --- OFF : ---

To change setting

1. Remove the upper case of interface PCB assy.
2. Change the switch setting on PCB.

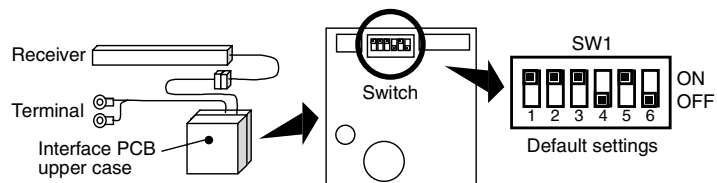

NOTE

When SW1-1 is turned to off position, change the wireless remote controller setting.

For the method of changing the setting, refer to **Setting to avoid mixed communication** on page 363.

③ How to install the control assy (In case of the pipe routed through the right)

The control assy (Receiver and interface PCB assy) can be installed inside the indoor unit.
After turning off the power and confirming safety, execute as follows.

In case of the piping routed from right side

① Preparation before installing Control assy

- Disconnect the receiver from the interface PCB assy, and attach on wiring assy (A).
- Change the original wiring (for X, Y) to the attached wiring assy (B).
- Bundle wiring with attached ties.
- Install the interface PCB assy on the left cover of the indoor unit with the attached insulation. (Refer to below figure.)

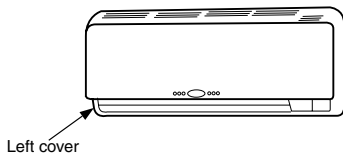
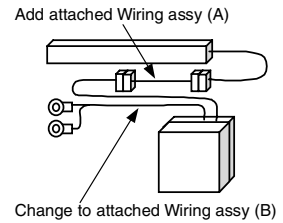

<FDK22-56>

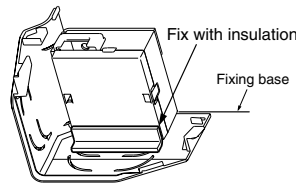

<FDK71>

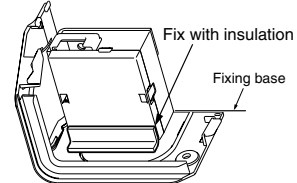

② Remove Panel

- Remove the fixing screw A and detach the unit bottom lid. (only FDK22-56)
- Remove the fixing screw B.
- Pull the lower part of the front panel off the unit toward you. And then, push it up to detach its upper part from the indoor unit. (Disengage 3 hooks located on the top part.)

<FDK22-56>

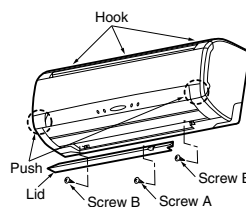

<FDK71>

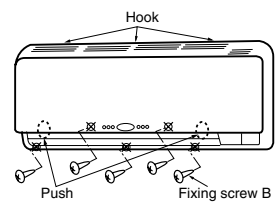

③ Install Receiver on Indoor unit

- Hang the claw of the receiver lower side on the claw of the indoor unit. (2 places)
And snap in the claw of the receiver upper side on the hole of the indoor unit. (2 places)
- Fix the wiring on the clip of the indoor unit. (2 places)

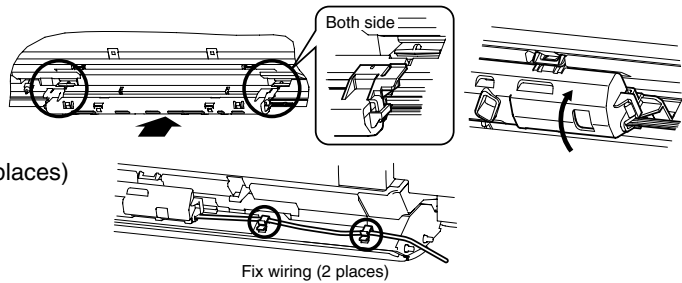

④ Install interface PCB assy on Indoor unit

- Route the Wiring assy (A) and (B) through the front of installation board.
- Install the cover in which the interface PCB assy is installed.

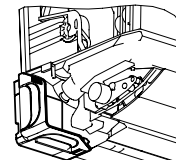
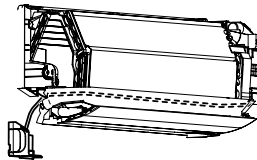
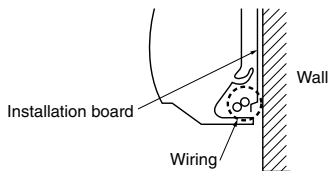

⑤ Fix Wiring assy (for X, Y)

- Fix the terminal of the wiring assy (for X, Y) on the terminal block of the indoor unit. (Non-polarized)
- Route the wiring as shown in figure.
- Bundle wirings with attached ties.

<FDK22-56>

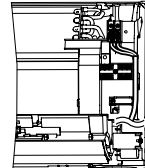

<FDK71>

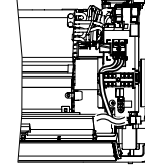

⑥ Put back Panel and stick Label on Panel

Refer to **③ How to install the control assy (Put back Panel and stick Label)** on page 362.

③ How to install the control assy (In case of the pipe routed through the left)

In case of the pipe routed through the left

① Preparation before installing Control assy

- a) Install the interface PCB assy on the right cover of the indoor unit with the attached insulation.

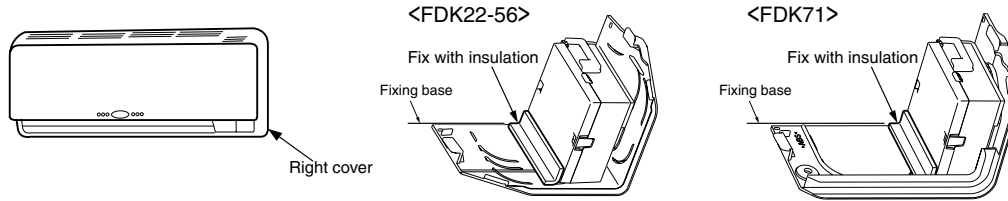

② Remove Panel

- a) Remove the fixing screw A and detach the unit bottom lid. (only FDK22-56)
 b) Remove the fixing screw B.
 c) Pull the lower part of the front panel off the unit toward you. And then, push it up to detach its upper part from the indoor unit. (Disengage 3 hooks located on the top part.)

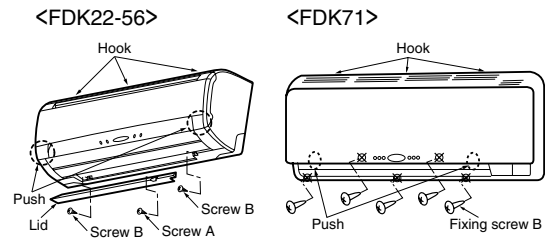

③ Install Receiver on Indoor unit

- a) Hang the claw of the receiver lower side on the claw of the indoor unit. (2 places)
 And snap in the claw of the receiver upper side on the hole of the indoor unit. (2 places)
 b) Fix the wiring on the clip of the indoor unit. (2 places)

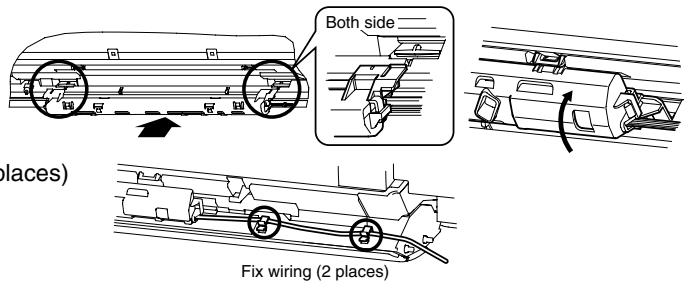

④ Install interface PCB assy on Indoor unit

- a) Install the cover in which the interface PCB assy is installed.

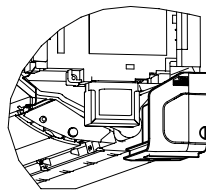

⑤ Fix Wiring assy (for X, Y)

- a) Fix the terminal of the wiring assy (for X, Y) on the terminal block of the indoor unit. (Non-polarized)
 b) Route the wiring as shown in figure.
 c) Bundle wirings with attached ties.

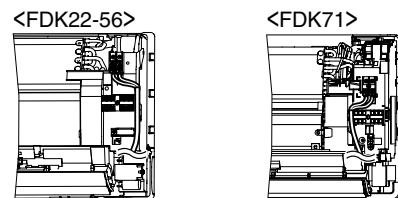

⑥ Put back Panel and stick Label on Panel

- Refer to ③ How to install the control assy (Put back Panel and stick Label) see next page

③ How to install the control assy (Put back Panel and stick Label)

Put back Panel and stick Label

① Put back Panel

- Always remove the air filter beforehand.
- Place the front panel over the indoor unit.
- Engage it onto the indoor unit by pressing the areas marked with  in the figure from the front.
- Fasten the fixing screw B.
- Set the air filter.
- Attach the indoor unit bottom lid and fasten the fixing screw A. (only FDK22-56)

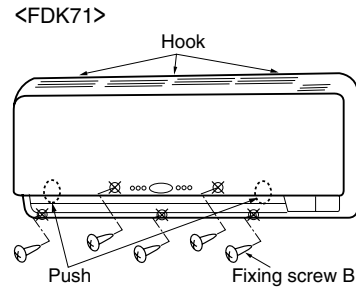
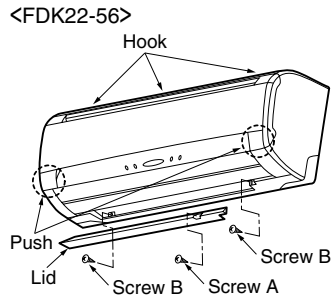

② Stick Label on Panel

Stick the attached label on the front panel.

Label ① must be stuck under the left side LED of the front panel.

Label ② must be stuck under the right side LED of the front panel.

<FDK22-56>

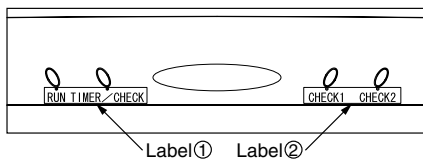

<FDK71>

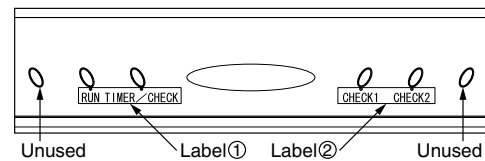

<Label ①>

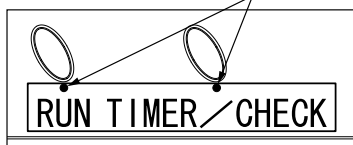

<Label ②>

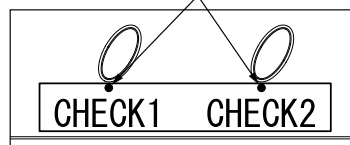

Label ① and ② have 2 dots.
Matched the dot on the label
and the bottom of the LED
hole.

④ How to install the wireless remote controller

⚠ CAUTION DO NOT install it in the following places.

1. Places exposed to direct sunlight
2. Hot surface or cold surface enough to generate condensation
3. Places near heat devices
4. Places directly exposed to oil mist or steam
5. High humidity places
6. Uneven surface

Installation tips for the remote controller holder

- Adjust and keep the holder up right.
- Tighten the screw to the end to avoid scratching the remote controller.
- DO NOT attach the holder on plaster wall.

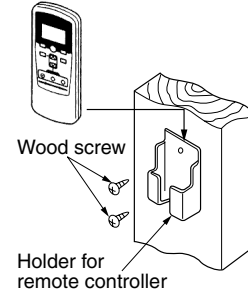

How to insert batteries

- ① Detach the back lid.
- ② Insert the batteries. (two AAA batteries)
- ③ Reattach the back lid.

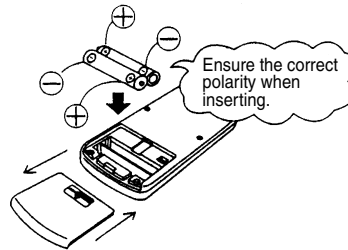

⑤ Function setting of interface PCB and wireless remote controller

Master/Slave setting when using plural remote controllers

Up to two wireless kit or wired remote controller can be installed in one indoor unit group.
When two wireless kit or wired remote controller are used, it is necessary to change setting on the PCB to slave.

Switch	Setting	Contents
Wired remote controller: SW1	Master	Master remote controller
Wireless kit: SW1-2	Slave	Slave remote controller

Setting to avoid mixed communication

In case of plural setting, check the operation distance of wireless remote controller, and avoid mixed communication.

Refer to **⑦ Wireless remote controller unit operation distance** on page 364 about the operation distance.
It is necessary to change setting of interface PCB and wireless remote controller.

(1) Interface PCB

Set SW1-1 to "OFF" position.

(2) Wireless remote controller

Pressing **ACL** and **AIR FLOW** button at the same time or inserting the batteries with pressing **AIR FLOW** button will customize the signal.

Setting to disable the Auto mode operation

VRF system (except heat recovery 3-pipe system) cannot be operated in Auto mode.
Make sure to set the remote controller for the models so as not to be able to choose Auto mode.

Pressing **ACL** and **MODE** button at the same time or inserting the batteries with pressing **MODE** button will make auto mode operation.

ATTENTION

When the batteries are removed, the setting will return to the default setting. Please make sure to reset it when the batteries are replaced.

⚠ Caution

Instruct the customer to set the mentioned above when replacing the batteries.
(How to set is also mentioned in the user's manual attached on the air conditioner.)

Radio prevention mode

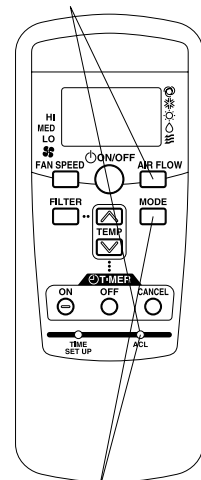

Auto mode operation setting

⑥ Wiring

Control plural indoor units with one remote controller

Up to 16 indoor units can be connected.

- ① Connect indoor units with each other with 2-core wires. As for size, refer to the following note.
- ② The receiver wires must be connected only with the indoor unit that will be operated by the remote controller directly.
- ③ Use the rotary SW1 and SW2 provided on the indoor unit PCB (Printed circuit board) to set unique remote control communication address avoiding duplication.

Restrictions on the thickness and length of wire
(Maximum total extension 600m.)

Standard	Within 100m x 0.3mm ²
	Within 200m x 0.5mm ²
	Within 300m x 0.75mm ²
	Within 400m x 1.25mm ²
	Within 600m x 2.0mm ²

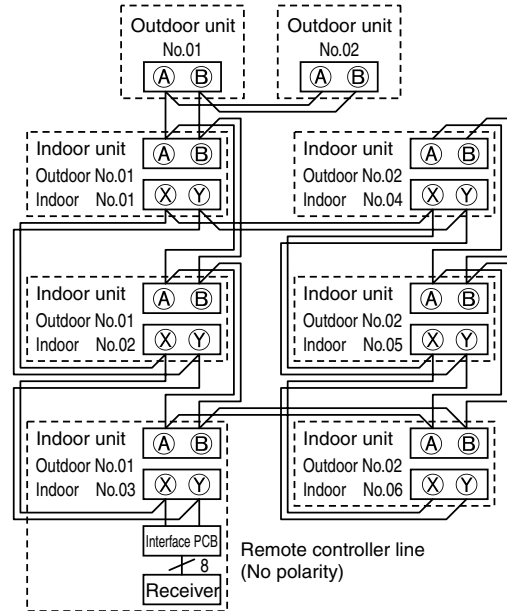

⑦ Wireless remote controller operation distance

- ① Standard signal receiving range

[Condition]

Illuminance at the receiver area: 360 lux.

(When no lighting fixture is located within 1m of indoor unit in an ordinary office)

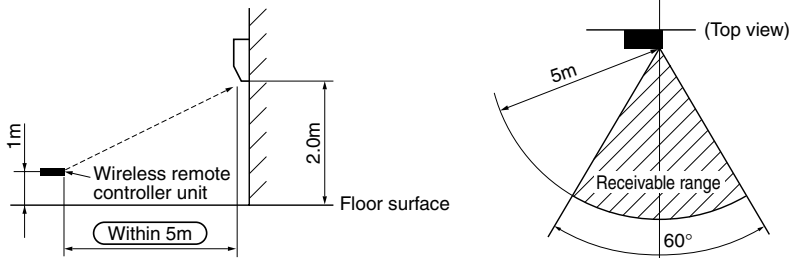

- ② Points for attention in connecting a plural number of indoor units

[Condition]

Illuminance at the receiver area: 360 lux.

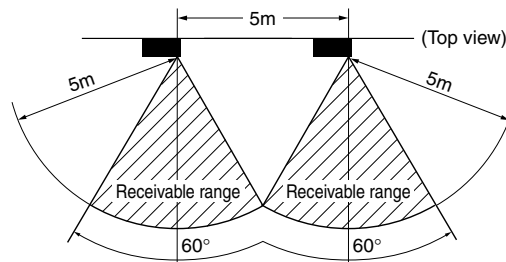

⑧ Trial operation

Backup switch

The backup switch is provided on the receiver section. It is possible to use the backup switch as shown in the figure below. When operation from the wireless remote controller unit is not possible (due to flat batteries, a mislaid unit, a unit failure), the backup switch can be used as an emergency means. The backup switch is operated manually.

- (1) If pressed while the air conditioner is in a halt, it will cause the air conditioner to start operation in the automatic mode (in the case of cooling only, in the cooling mode).
Fan speed: Hi fan, Temperature setting: 23°C, Louver: horizontal
- (2) If pressed while the air conditioner is in operation, it will stop the air conditioner.

<FDK22-56>

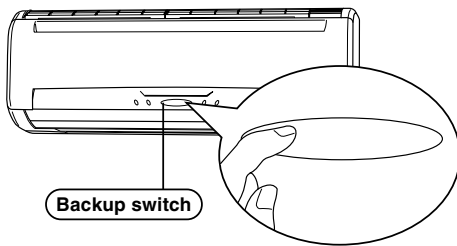

<FDK71>

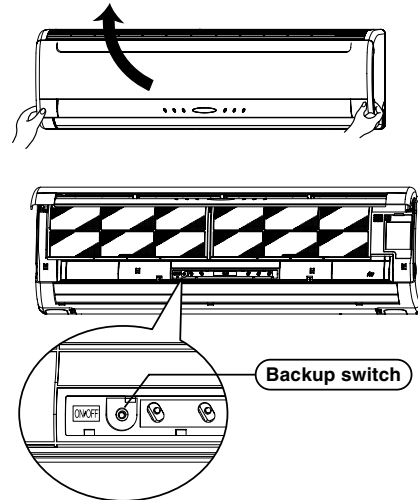

Cooling test run operation

- After safety confirmation, turn on the power.
- Transmit a cooling operation command with the wireless remote controller, while the backup switch on the receiver is depressed.
- If the backup switch on the receiver is pressed during a test run, it will end the test run.
- If the air conditioner can not operate properly during the test run, check wiring according to the trouble shooting guides.

NOTE

1. After over 2 minute from power on, operate the wireless remote controller.
The operation is invalid during 2 minute from power on.
2. Check indicator lamp "check1" / "check2" shows error code.
The number of blinking shows the error code number of tens/ones place and check1/check2 corresponds to tens/ones place.

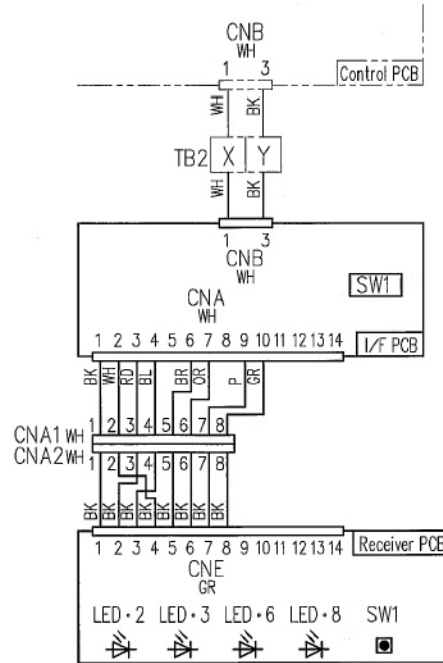
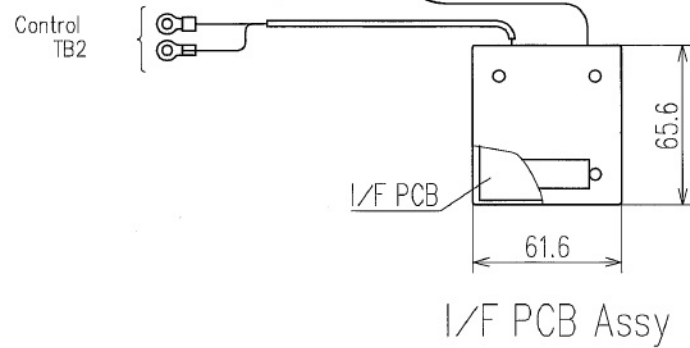
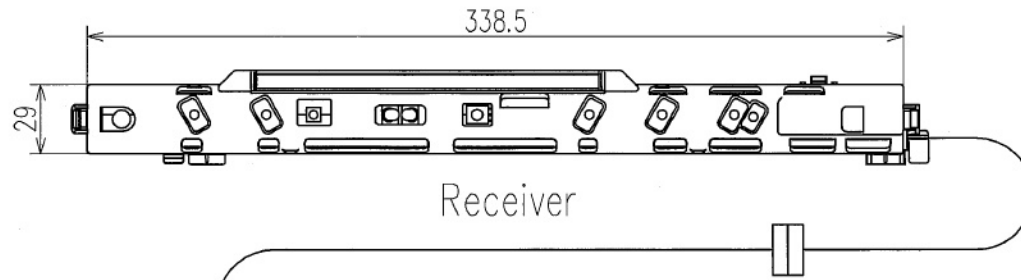

- Notes (1) Two R03 AAA dry cell batteries for remote controller are enclosed.
 (2) See spec sheet of "Wireless remote controller" about remote controller.
 (3) In case of pipe through right, use attached wirings.

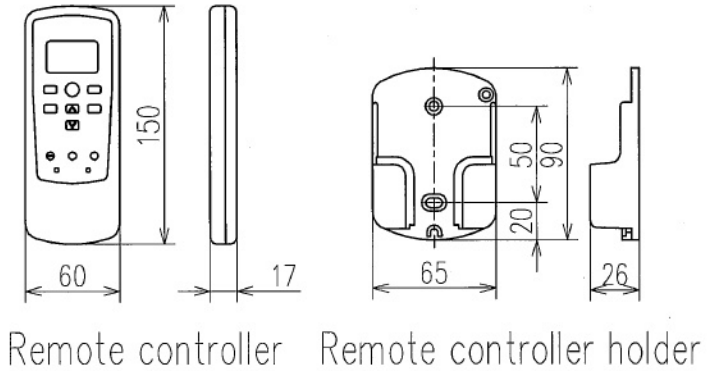

Setting switch on I/F PCB

SW1-1	Prevents interference during plural setting	ON: Normal (1ch)	OFF: Customized (2ch)
SW1-2	Receiver master/slave setting	ON: Master	OFF: Slave
SW1-3	Buzzer valid/Invalid	ON: Valid	OFF: Invalid
SW1-4	Auto restart	ON: Valid	OFF: Invalid
SW1-5	Indication for error	ON: Valid	OFF: Invalid
SW1-6	No use	ON: ---	OFF: ---

mark : Default setting

On Receiver PCB

SW1	Backup SW
LED-2	Run
LED-3	Check1
LED-6	Timer/Check
LED-8	Check2

Color Marks

Mark	Color
BK	Black
BL	Blue
BR	Brown
GR	Gray
OR	Orange
P	Pink
RD	Red
WH	White

DO NOT install on the following places.

- (1) Places exposed to direct sunlight
- (2) Hot surface or cold surface enough to generate condensation
- (3) Places near heat devices
- (4) Places exposed to oil mist or steam directly
- (5) High humidity places
- (6) Uneven surface

